













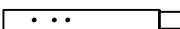







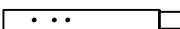



Fashion Bed Group

A Division of Leggett & Platt Incorporated
5950 West 51st Street - Chicago, IL 60638

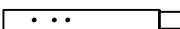
Parts List For Sylvania

BED CARTON	HEADBOARD CARTON											
<p>(10) HEADBOARD PANEL (11) FOOTBOARD PANEL PART #368501 HARDWARE BAG FOR BED ATTACHMENT TO FRAME (1) 1/4-20 X 2 1/4" LONG FLAT ALLEN HEAD SCREW-4 (2) 1/4-20 X 1" LONG FLAT ALLEN HEAD SCREW-4 (3) 1/4-20 HEX NUT-4 (4) 1/4" ID FLAT WASHER-8 (5) ALLEN WRENCH (6) EXTENSION LEG-2 #368503 (7) FINIAL-4 #368504 (8) FOOT CASTING-2 #368505 (9) PLASTIC GLIDES-4 #368506</p>	<p>(10) HEADBOARD PANEL PART #368502 HARDWARE BAG FOR HEADBOARD ATTACHMENT TO FRAME (1) 1/4-20 X 2 1/4" LONG FLAT ALLEN HEAD SCREW-4 (3) 1/4-20 HEX NUT-4 (4) 1/4" ID FLAT WASHER-4 (5) ALLEN WRENCH (6) EXTENSION LEG-2 #368503 (7) FINIAL-2 #368504 (9) PLASTIC GLIDES-2 #368506</p>	<table border="1"> <tr> <td data-bbox="927 472 1062 569">1 </td> <td data-bbox="1062 472 1170 569">2 </td> <td data-bbox="1170 472 1279 569">3 </td> <td data-bbox="1279 472 1388 569">4 </td> <td data-bbox="1388 472 1521 569">5 </td> </tr> <tr> <td colspan="2" data-bbox="927 569 1170 695">6 </td> <td data-bbox="1170 569 1279 695">7 </td> <td data-bbox="1279 569 1388 695">8 </td> <td data-bbox="1388 569 1521 695">9 </td> </tr> </table>	1 	2 	3 	4 	5 	6 		7 	8 	9 
1 	2 	3 	4 	5 								
6 		7 	8 	9 								
		<table border="1"> <tr> <td data-bbox="927 695 1219 846">10 </td> <td data-bbox="1219 695 1521 846">11 </td> </tr> </table>	10 	11 								
10 	11 											

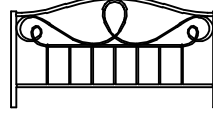
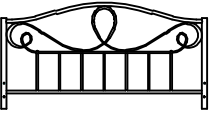
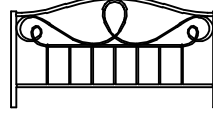
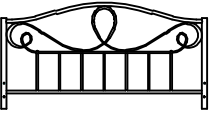
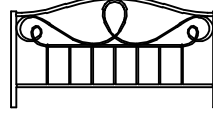
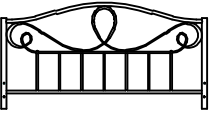
PRODUCT FULLY ASSEMBLED

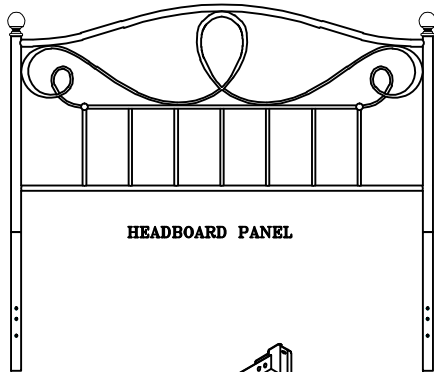

HEADBOARD PANEL

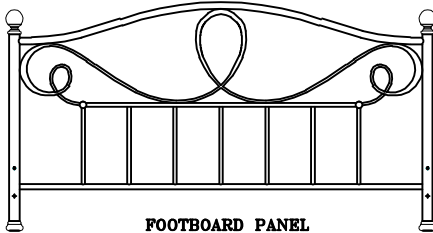

FOOTBOARD PANEL

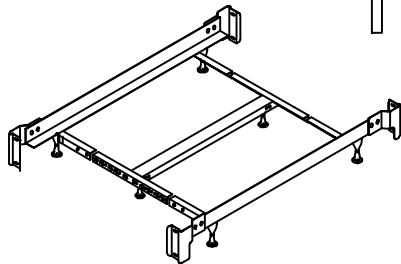

QUEEN - KING BED FRAME FULLY ASSEMBLED

NOTE: SEE INSTRUCTIONS INCLUDED IN FRAME CARTON FOR FRAME ASSEMBLY

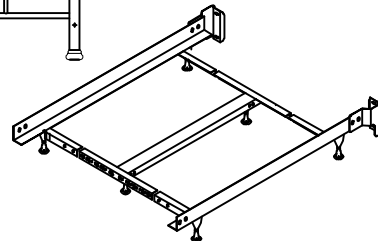

QUEEN - KING HEADBOARD ONLY FRAME FULLY ASSEMBLED

NOTE: SEE INSTRUCTIONS INCLUDED IN FRAME CARTON FOR FRAME ASSEMBLY

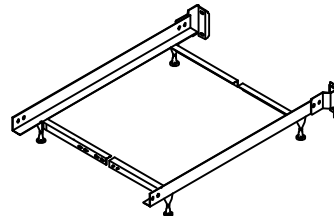

TWIN - FULL HEADBOARD ONLY FRAME FULLY ASSEMBLED

NOTE: SEE INSTRUCTIONS INCLUDED IN FRAME CARTON FOR FRAME ASSEMBLY

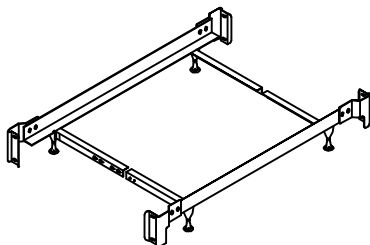

TWIN - FULL BED FRAME FULLY ASSEMBLED

NOTE: SEE INSTRUCTIONS INCLUDED IN FRAME CARTON FOR FRAME ASSEMBLY

FOR ASSISTANCE IN ASSEMBLY ONLY OF THIS PRODUCT. CALL OUR HELP DESK AT 1-800-324-3415, BETWEEN 8:30 AM & 4:30 PM CENTRAL TIME MONDAY THRU FRIDAY. PLEASE HAVE THE STYLE NUMBER AVAILABLE BEFORE YOU CALL. (STYLE # OR NAME CAN BE FOUND ON PACKING CARTON OR SALES RECEIPT.) OUR PRODUCT IS INSPECTED TO ENSURE IT IS IN GOOD CONDITION. IF YOUR FURNITURE APPEARS TO HAVE BEEN DAMAGED IN SHIPMENT OR YOU ARE IN NEED OF REPLACEMENT PARTS PLEASE CONTACT THE DEALER FROM WHOM YOU PURCHASED THE PRODUCT.

Instruction Sheet

SAVE ALL PACKAGING MATERIALS UNTIL PRODUCT IS FULLY ASSEMBLED. HARDWARE AND SMALL PIECES MAY NOT BE SEEN AND COULD BE ACCIDENTALLY DISCARDED WITH PACKAGING MATERIALS.

FIGURE 1

HEADBOARD PANEL

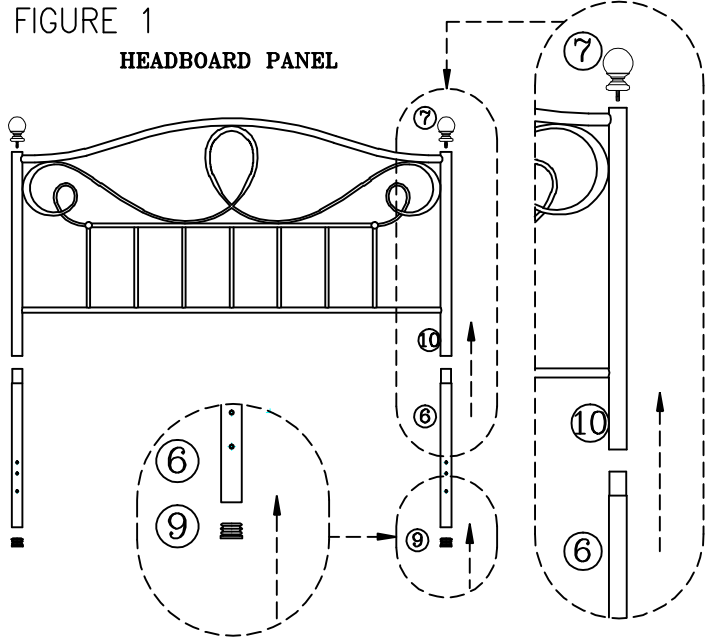

FIGURE 2

FOOTBOARD PANEL

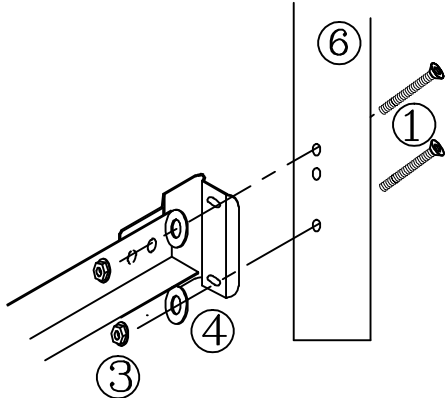
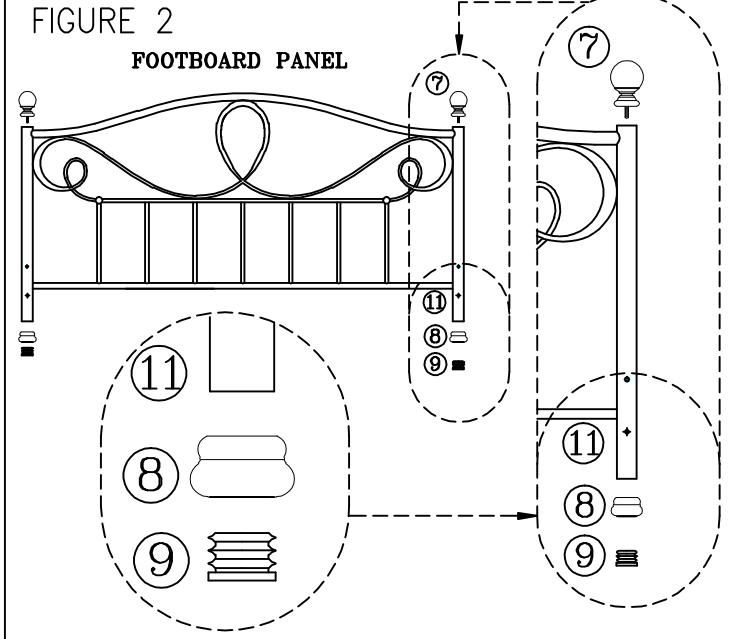

FIGURE 3

Step 1 Headboard Assembly

- Insert plastic glide (9) on extension leg (6). SEE FIGURE 1
- Align top reduction of extension legs (6) with bottom of headboard panel (10) posts. (SEE FIGURE 1) Make sure the 3 holes on extension legs are perpendicular to headboard panel.
- Now carefully insert extension legs (6) into bottom of headboard (10) posts.
- Screw in finials (7) on top of headboard Panel (10). (SEE FIGURE 1)

Step 2 Footboard Assembly

- Insert foot ring (8) into footboard panel post (11). (SEE FIGURE 2)
- Secure foot ring (8) with plastic glide (9).
- Screw in finials (7) on top of footboard Panel (11). (SEE FIGURE 2)

Step 3 Headboard Frame Assembly

- Place headboard and frame in desired location in room.
- Place 2 screws (1) through holes located in extension leg (6). (SEE FIGURE 3)
- Align bed frame bracket over screws.
- Place a flat metal washer (4) over screws first and then a nut (3) on each screw. Hand tighten, DO NOT TIGHTEN screws all the way.
- Repeat on other side of headboard.
- Tighten all screws securely using the Allen wrench (5).

Step 3 Footboard Frame Assembly

- Position footboard panel (11) and align holes in the post with holes in the frame bracket. (SEE FIGURE 4)
- Place flat metal washer (4) on each screw (2). Insert through bracket and into footboard post. Hand tighten, DO NOT TIGHTEN screws all the way.
- Repeat on other side of footboard panel.
- Tighten all screws securely using the Allen wrench (5).

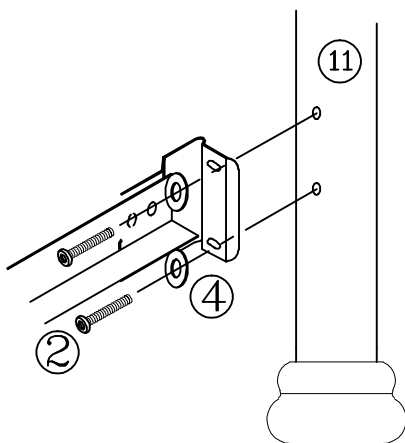

FIGURE 4