





































Fashion Bed Group

A Division of Leggett & Platt Incorporated
5950 West 51st Street - Chicago, IL 60638

Parts List For Pomona Bed

BED CARTON	HEADBOARD CARTON																				
<p>(11) HEADBOARD PANEL (12) FOOTBOARD PANEL</p> <p>PART #369001 HARDWARE BAG FOR FRAME ATTACHMENT</p> <p>(1) 1/4-20 X 2 1/2" FLAT ALLEN HEAD SCREW-4 (2) 1/4-20 X 1" FLAT ALLEN HEAD SCREW-4 (3) 1/4-20 X 3/4" FLAT ALLEN HEAD SCREW-4 (4) 1/4" (ID) FLAT METAL WASHER - 12 (5) 1/4" (ID) LOCK METAL WASHER - 8 (6) 1/4 - 20 HEX NUTS - 4 (7) ALLEN WRENCH- 1 (8) OPEN END WRENCH -1</p> <p>(9) LEG. EXTENSIONS - 2 # 369003 (10) PLASTIC GLIDES - 4 # 150950000</p> <p>NOTE: GLIDES COME PRE-INSERTED</p>	<p>(11) HEADBOARD PANEL</p> <p>PART #369002 HARDWARE BAG FOR FRAME ATTACHMENT</p> <p>(1) 1/4-20 X 2 1/2" FLAT ALLEN HEAD SCREW-4 (3) 1/4-20 X 3/4" FLAT ALLEN HEAD SCREW-4 (4) 1/4" (ID) FLAT METAL WASHER - 8 (5) 1/4" (ID) LOCK METAL WASHER - 4 (6) 1/4 - 20 HEX NUTS - 4 (7) ALLEN WRENCH- 1 (8) OPEN END WRENCH -1</p> <p>(9) LEG. EXTENSIONS - 2 # 369003 (10) PLASTIC GLIDES - 4 # 150950000</p> <p>NOTE: GLIDES COME PRE-INSERTED</p>	<table border="1"> <tr> <td data-bbox="1029 478 1170 604">1 </td> <td data-bbox="1170 478 1279 604">2 </td> <td data-bbox="1279 478 1388 604">3 </td> <td data-bbox="1388 478 1497 604">4 </td> </tr> <tr> <td data-bbox="1029 604 1170 730">5 </td> <td data-bbox="1170 604 1279 730">6 </td> <td data-bbox="1279 604 1388 730">7 </td> <td data-bbox="1388 604 1497 730">8 </td> </tr> <tr> <td colspan="2" data-bbox="1029 730 1279 856">9 </td> <td colspan="2" data-bbox="1279 730 1497 856">10 </td> </tr> <tr> <td colspan="2" data-bbox="1029 856 1279 982">11 </td> <td colspan="2" data-bbox="1279 856 1497 982">12 </td> </tr> </table>				1 	2 	3 	4 	5 	6 	7 	8 	9 		10 		11 		12 	
1 	2 	3 	4 																		
5 	6 	7 	8 																		
9 		10 																			
11 		12 																			

PRODUCT FULLY ASSEMBLED

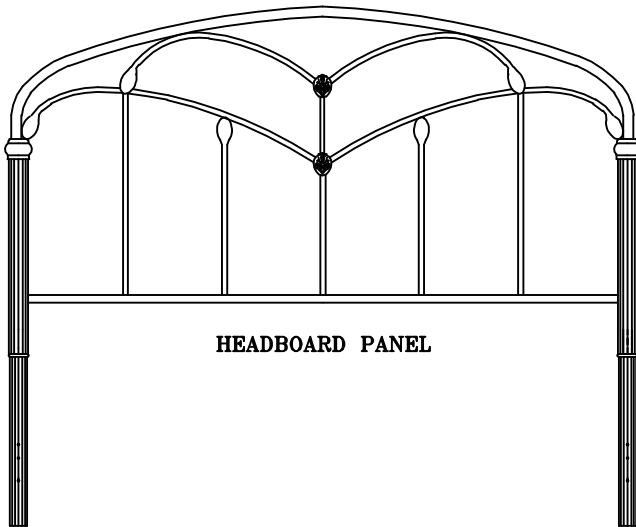

HEADBOARD PANEL

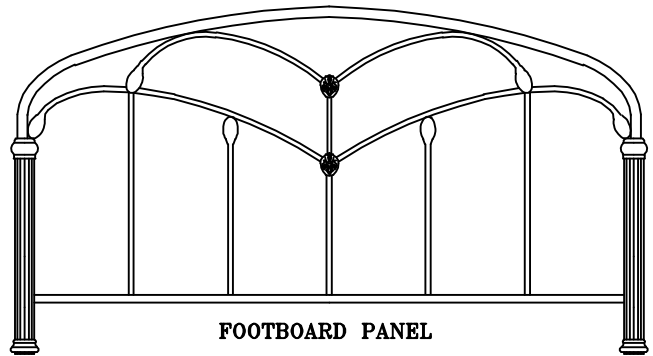

FOOTBOARD PANEL

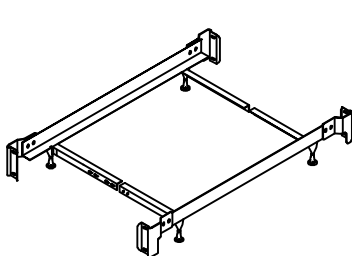

TWIN - FULL BED FRAME FULLY ASSEMBLED

NOTE: SEE INSTRUCTIONS INCLUDED IN FRAME CARTON FOR FRAME ASSEMBLY

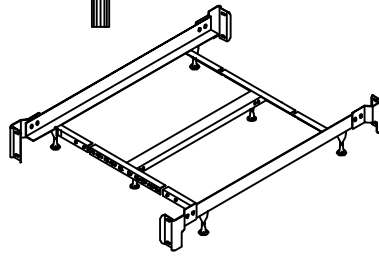

QUEEN - KING BED FRAME FULLY ASSEMBLED

NOTE: SEE INSTRUCTIONS INCLUDED IN FRAME CARTON FOR FRAME ASSEMBLY

FOR ASSISTANCE IN ASSEMBLY ONLY OF THIS PRODUCT. CALL OUR HELP DESK AT 1-800-324-3415, BETWEEN 8:30 AM & 4:30 PM CENTRAL TIME MONDAY THRU FRIDAY. PLEASE HAVE THE STYLE NUMBER AVAILABLE BEFORE YOU CALL. (STYLE # OR NAME CAN BE FOUND ON PACKING CARTON OR SALES RECEIPT.) OUR PRODUCT IS INSPECTED TO ENSURE IT IS IN GOOD CONDITION. IF YOUR FURNITURE APPEARS TO HAVE BEEN DAMAGED IN SHIPMENT OR YOU ARE IN NEED OF REPLACEMENT PARTS PLEASE CONTACT THE DEALER FROM WHOM YOU PURCHASED THE PRODUCT.

Instruction Sheet

SAVE ALL PACKAGING MATERIALS UNTIL PRODUCT IS FULLY ASSEMBLED. HARDWARE AND SMALL PIECES MAY NOT BE SEEN AND COULD BE ACCIDENTALLY DISCARDED WITH PACKAGING MATERIALS.

FIGURE 1

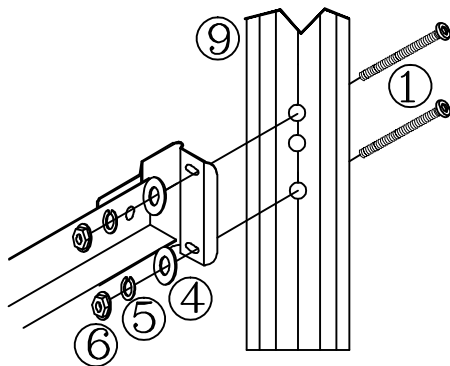
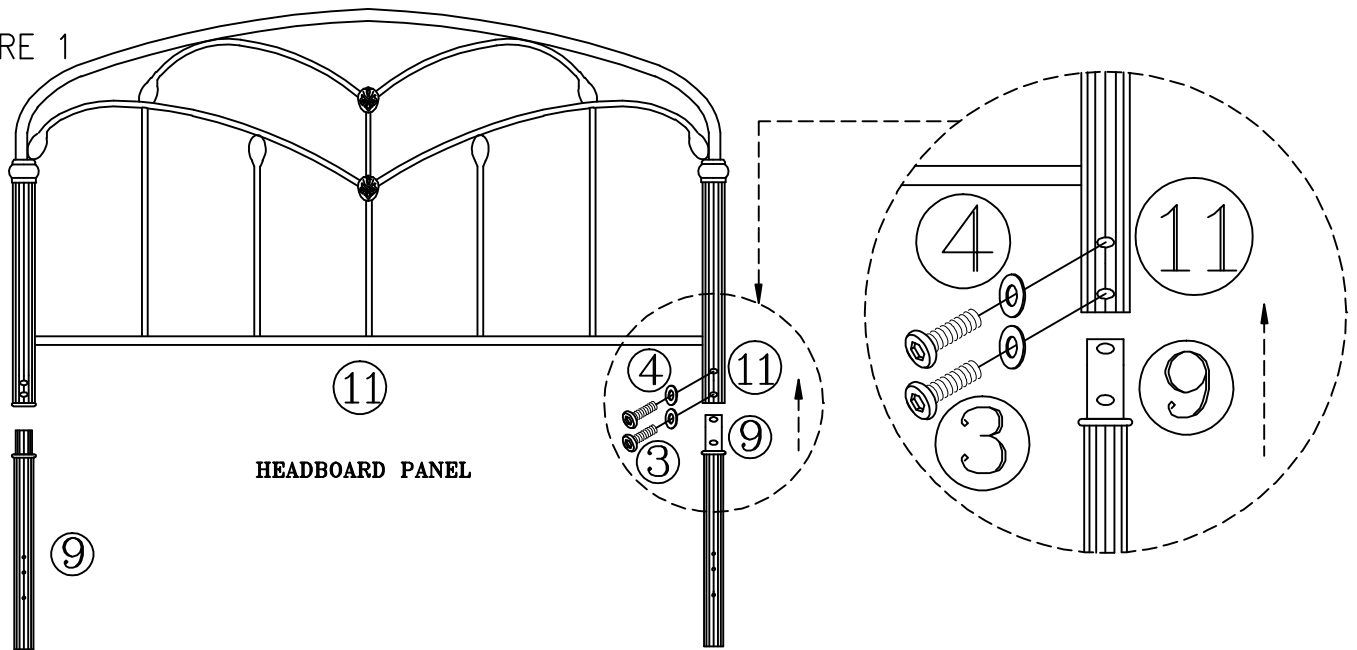

FIGURE 2

Step 1

- Align top reduction of leg extension (9) with bottom of headboard panel (11) posts . (SEE FIGURE 1)
- Now carefully insert leg extension (9) into bottom of headboard panel (11) post.
- Secure leg extension with screw (3) and flat metal washer (4) using allen wrench (7).

Step 2

- Place headboard and frame in desired location in room.
- Place 2 screws (1) through holes located in leg (9) (SEE FIGURE 2)
- Align bed frame bracket over screws.
- Place a flat metal washer (4), lock washer (5) and hex nut (6) over on each screw. Hand tighten. DO NOT TIGHTEN screws all the way. (SEE FIGURE 2)
- Repeat on other side of headboard.
- Tighten all screws securely using the Allen wrench (7) and open wrench (8).

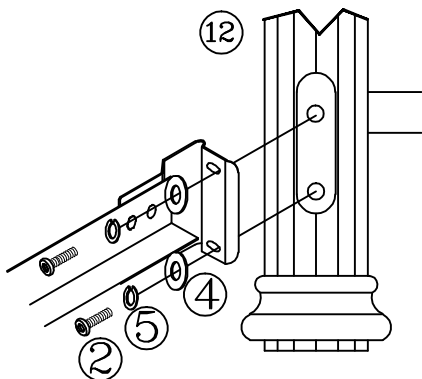

Step 3

- Position footboard panel (12) and align holes in the post with holes in the frame bracket. (SEE FIGURE 3)
- Place a lock washer (5) and flat metal washer (4) over on each screw (2). Insert through bracket and into post. Hand tighten. DO NOT TIGHTEN screws all the way.
- Repeat on other side of footboard panel.
- Tighten all screws securely using the Allen wrench (7).