

leggett & platt®

fashion bed™

6755 W. 65th Street Bedford Park, IL 60638

Parts List For Bianca Daybed

PART #368801 MOUNTING FRAME HARDWARE BAG

- (1) 6MM X 80MM ALLEN HEAD SCREW-8
- (2) 6MM HEX NUTS-8
- (3) 6MM ID FLAT METAL WASHER-16
- (4) ALLEN WRENCH-1
- (5) FINIAL-4 #368803

PART #368802 MOUNTING GRILL HARDWARE BAG

- (1) 6MM X 80MM ALLEN HEAD SCREW-12
- (4) ALLEN WRENCH-1

DAYBED PARTS:

- (6) SIDE PANEL GRILL-2
- (7) SIDE PANEL BACK POST-2
- (8) SIDE PANEL FRONT POST-2
- (9) BACK PANEL-1

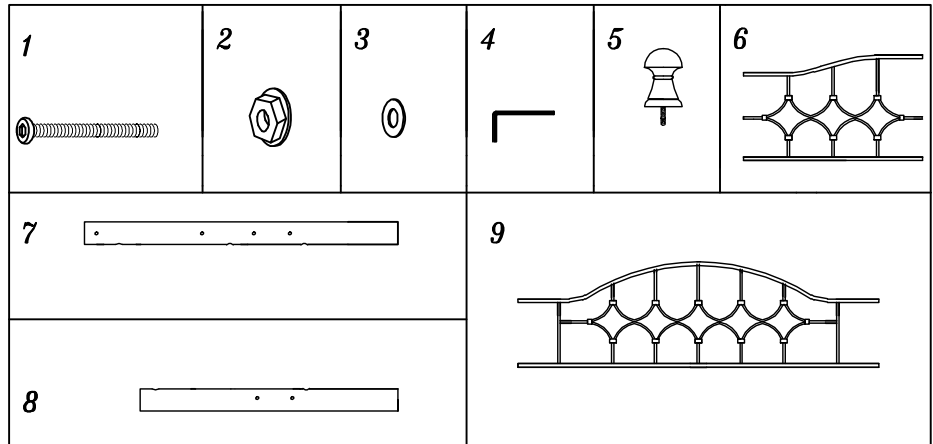

SAVE ALL PACKAGING MATERIALS UNTIL PRODUCT IS FULLY ASSEMBLED. HARDWARE AND SMALL PIECES MAY NOT BE SEEN AND COULD BE ACCIDENTALLY DISCARDED WITH PACKAGING MATERIALS.

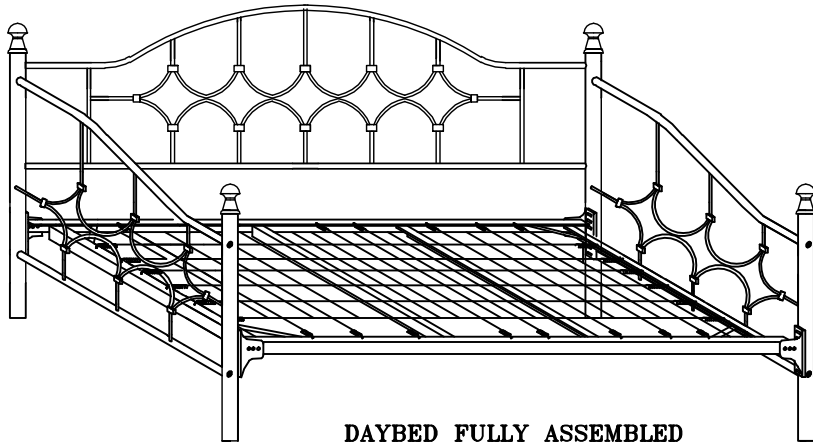

DAYBED FULLY ASSEMBLED

Instruction Sheet • For ease of assembly you will need a helper.
 • Periodically retighten all screws.

STEP 1- Locate hardware bag for Daybed & Link Spring Assembly.

- Hardware bag for daybed assembly is located inside the daybed box.
- Link spring – follow manufacturer instructions to assembly end brackets to link spring before attaching to daybed

OPTIONAL

"LINK SPRING SOLD SEPARATELY"

"TRUNDLE UNIT SOLD SEPARATELY"

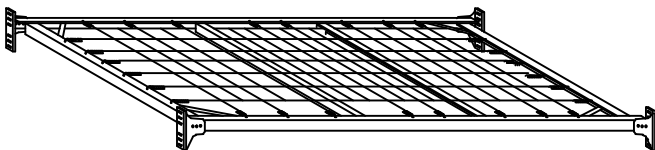

LINK SPRING FULLY ASSEMBLED

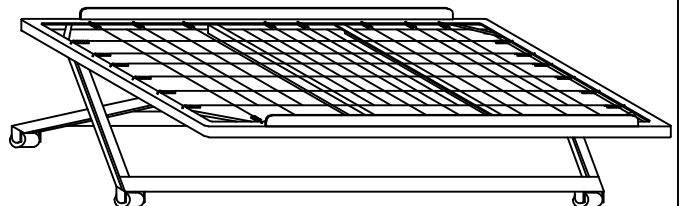

Instruction Sheet

STEP 2– Assembly of Side Panel.

- Align side panel rail ends (6) to holes in front post (8) and back post (7). SEE FIGURE 1
- Insert screw (1) through holes on opposite side of post.
- Secure post with screw (1) use allen wrench (4).
- Screw finial (5) over top of side panel front and back post. SEE FIGURE 1

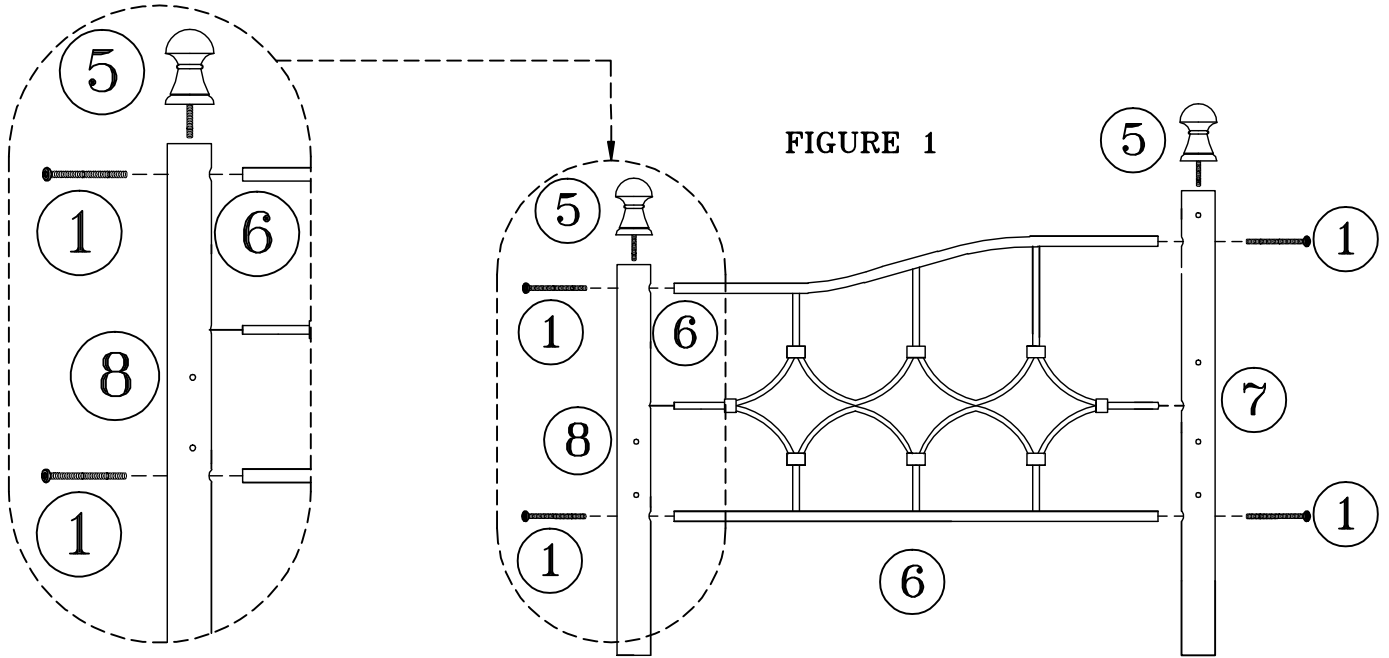

STEP 3– Assembly of Back Panel.

- Align back rails end (9) to holes in side panel back post (7). SEE FIGURE 2
- Insert screw (1) through holes on opposite side of post into back panel rails.
- Hand tighten. DO NOT TIGHTEN screws all the way use allen wrench (4).
- Repeat on other end of back panel.

NOTES:

- Do not tighten all screws until the mattress support system and the back panel of the daybed have been assembled to the side arms.
- After assembly of the mattress support system and the back panel to the sides tighten all connections
- Periodically retighten all screws.

FIGURE 2

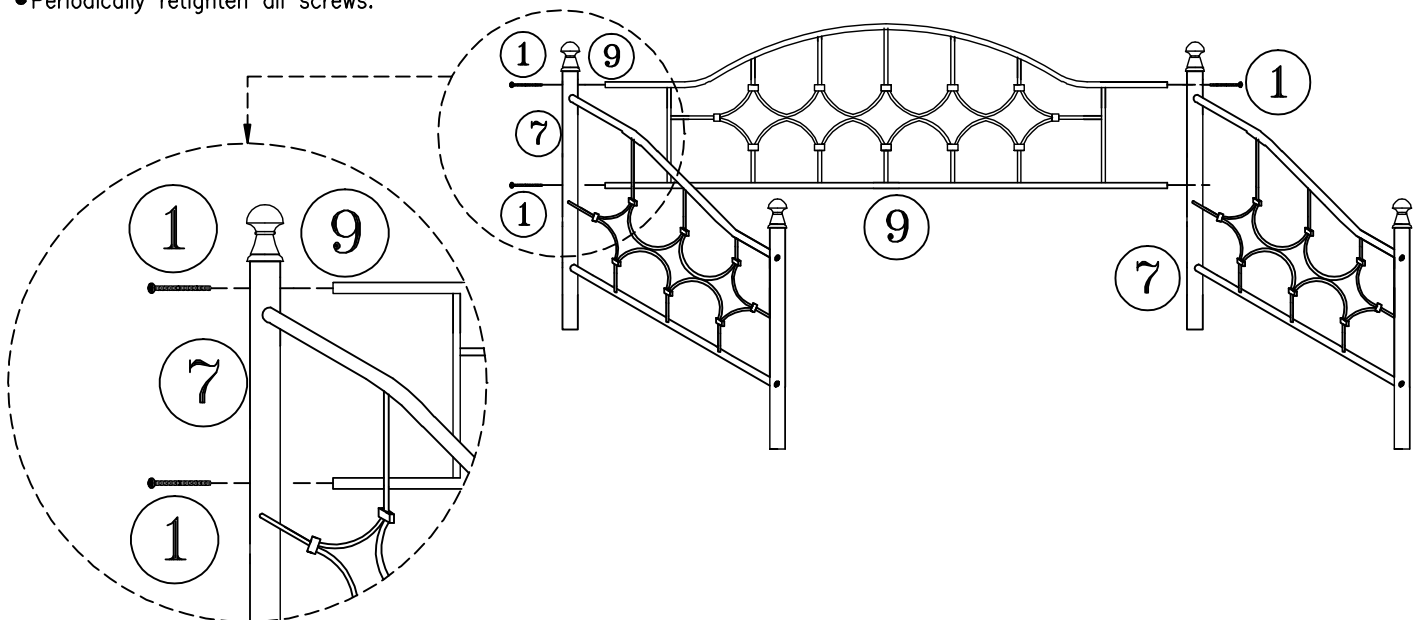

Instruction Sheet

STEP 4- Assembly of Link Spring.

- Bolt one end bracket of the mattress support system to one daybed side panel.
- For each post use 2 screws (1) 2 flat metal washers (3), and 2 hex nuts (2), loosely tighten. SEE FIGURE 3
- Repeat on the other daybed post.
- You are ready now for mattress installation.

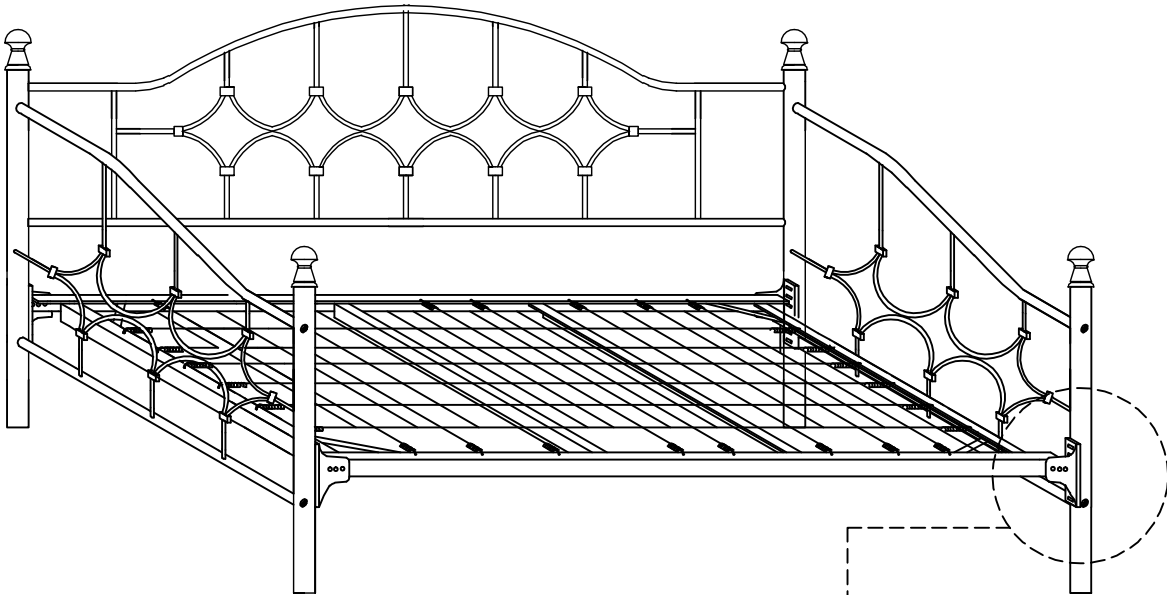
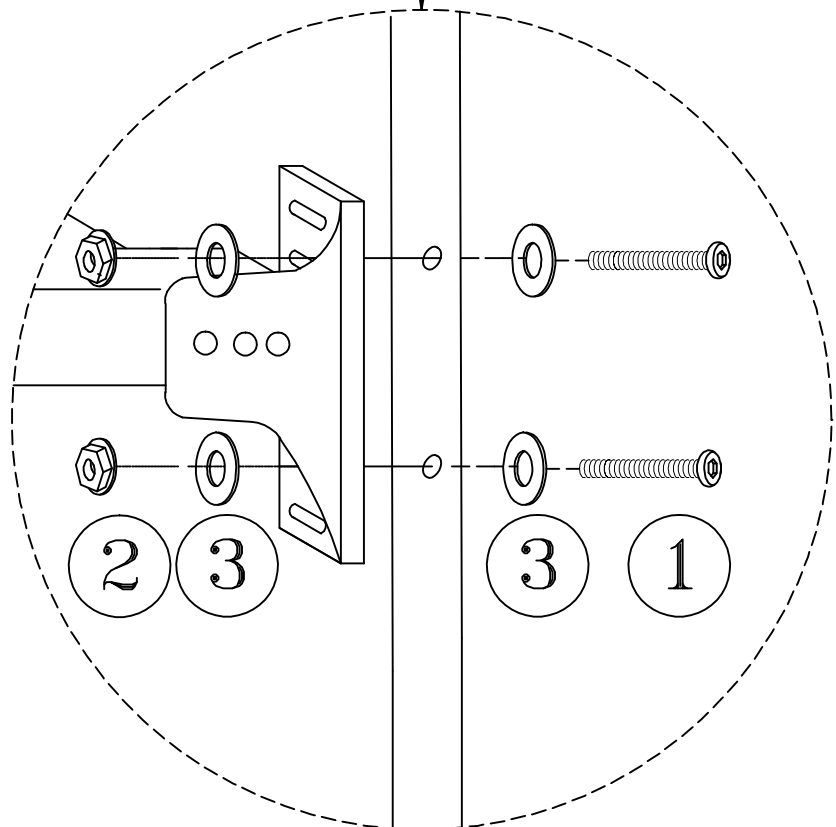

FIGURE 3



FOR ASSISTANCE IN ASSEMBLY ONLY OF THIS PRODUCT. CALL OUR HELP DESK AT 1-800-324-3415, BETWEEN 8:30 AM & 4:30 PM CENTRAL TIME MONDAY THRU FRIDAY. PLEASE HAVE THE STYLE NUMBER AVAILABLE BEFORE YOU CALL. (STYLE # OR NAME CAN BE FOUND ON PACKING CARTON OR SALES RECEIPT.) OUR PRODUCT IS INSPECTED TO ENSURE IT IS IN GOOD CONDITION. IF YOUR FURNITURE APPEARS TO HAVE BEEN DAMAGED IN SHIPMENT OR YOU ARE IN NEED OF REPLACEMENT PARTS PLEASE CONTACT THE DEALER FROM WHOM YOU PURCHASED THE PRODUCT.