







FASHION BED GROUP.

A *Lovett & Platt* COMPANY

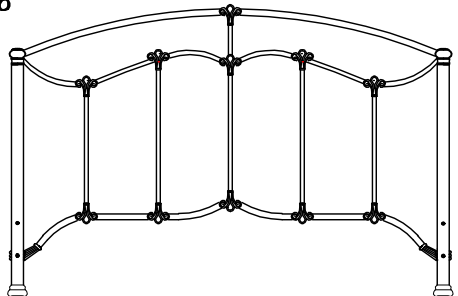
6755 W. 65th Street-Bedford Park, IL 60638

Parts List For Amberley HD/FT Duo

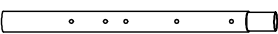
CARTON	1	2	3	8
PART#406703 CHROME FINISH HARDWARE BAG FOR HD/FT/DUO FRAME ATTACHMENT (1) 1/4-20 X 2 1/4" COUNTERSUNK ALLEN HEAD SCREW-4 (2) 1/4-20 X 1" FLAT ALLEN HEAD SCREW-4 (3) 1/4" ID FLAT METAL WASHER-4 (4) 1/4-20 HEX NUT-4 (5) ALLEN WRENCH (6) PLASTIC GLIDE-2 (7) LEG EXTENSION-2 (8) HD/FT/DUO PANEL-1				
				
				

PRODUCT FULLY ASSEMBLED

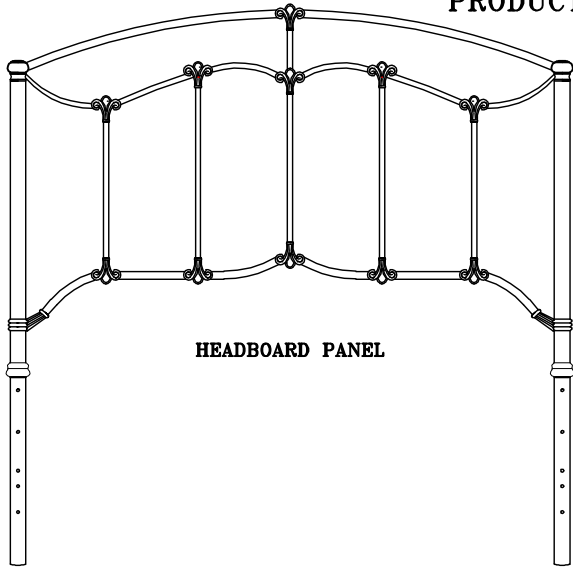

HEADBOARD PANEL

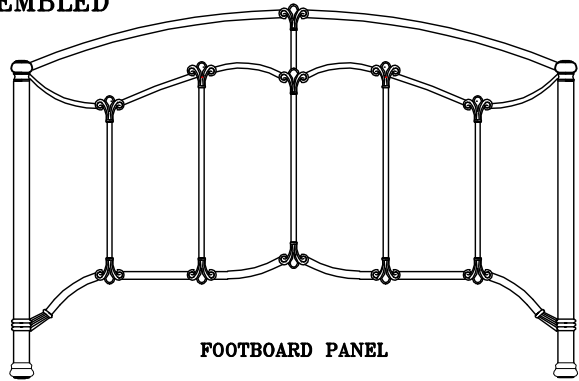

FOOTBOARD PANEL

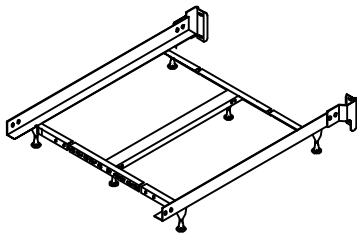

QUEEN - KING HEADBOARD ONLY FRAME FULLY ASSEMBLED FRAMES

NOTE: SEE INSTRUCTIONS INCLUDED IN FRAME CARTON FOR FRAME ASSEMBLY

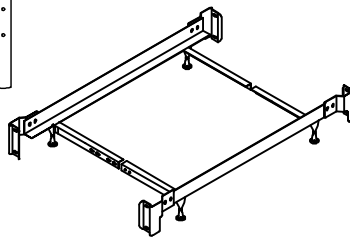

TWIN - FULL BED FRAME FULLY ASSEMBLED

NOTE: SEE INSTRUCTIONS INCLUDED IN FRAME CARTON FOR FRAME ASSEMBLY

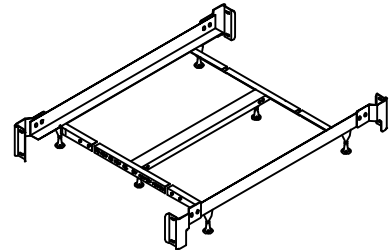

QUEEN - KING BED FRAME FULLY ASSEMBLED

NOTE: SEE INSTRUCTIONS INCLUDED IN FRAME CARTON FOR FRAME ASSEMBLY

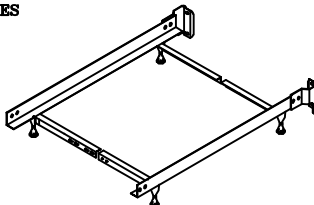

TWIN - FULL HEADBOARD ONLY FRAME FULLY ASSEMBLED

NOTE: SEE INSTRUCTIONS INCLUDED IN FRAME CARTON FOR FRAME ASSEMBLY

FOR ASSISTANCE IN ASSEMBLY ONLY OF THIS PRODUCT. CALL OUR HELP DESK AT 1-800-324-3415, BETWEEN 8:30 AM & 4:30 PM CENTRAL TIME MONDAY THROUGH FRIDAY. PLEASE HAVE THE STYLE NUMBER AVAILABLE BEFORE YOU CALL. (STYLE # OR NAME CAN BE FOUND ON PACKING CARTON OR SALES RECEIPT.) OUR PRODUCT IS INSPECTED TO ENSURE IT IS IN GOOD CONDITION. IF YOUR FURNITURE APPEARS TO HAVE BEEN DAMAGED IN SHIPMENT OR YOU ARE IN NEED OF REPLACEMENT PARTS PLEASE CONTACT THE DEALER FROM WHOM YOU PURCHASED THE PRODUCT.

Instruction Sheet

SAVE ALL PACKAGING MATERIALS UNTIL PRODUCT IS FULLY ASSEMBLED. HARDWARE AND SMALL PIECES MAY NOT BE SEEN AND COULD BE ACCIDENTALLY DISCARDED WITH PACKAGING MATERIALS.

FIGURE 1

HEADBOARD ASSEMBLY

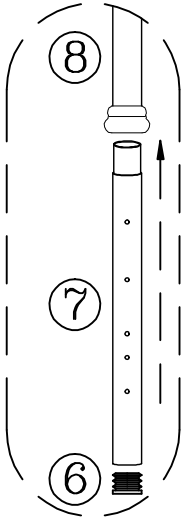

FOOTBOARD ASSEMBLY

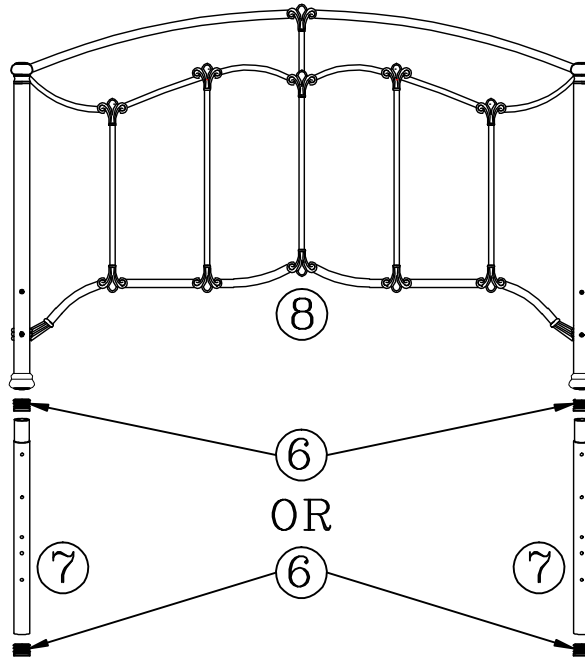
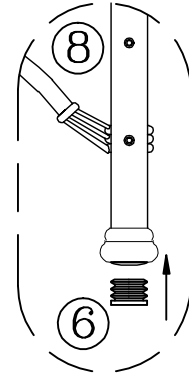
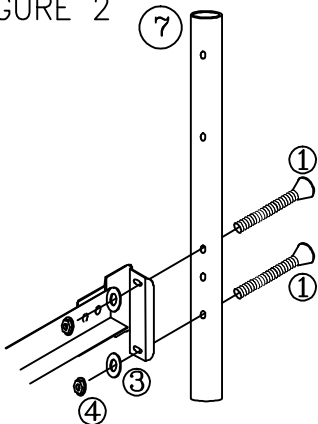

FIGURE 2



NOTE: This product can be used as Headboard only or as Headboard/Footboard bed. Insert plastic glide (6) into leg extension (7) for headboard assembly. For footboard assembly insert plastic glide (6) into bottom of panel (8) posts.

Step 1 Headboard Assembly

- Insert plastic glide (6) on leg extension (7). SEE FIGURE 1
- Align holes on top reduction of leg extension (7) with bottom of headboard panel post (8). SEE FIGURE 1 Make sure the holes on leg extension are perpendicular to panel.
- Now carefully insert leg extension (7) into bottom of headboard panel (8) posts. SEE FIGURE 1
- Repeat on other side of panel.

Step 2 Frame Assembly

- Place headboard and frame in desired location in room.
- Place 2 screws (1) through holes located in leg extension (7). SEE FIGURE 2
- Align bed frame bracket over screws.
- Place flat washer (3) first and then a hex nut (4) on each screw. Hand tighten, DO NOT TIGHTEN screws all the way.
- Repeat on other side of headboard.
- Tighten all screws securely using the Allen wrench (5).

FIGURE 3

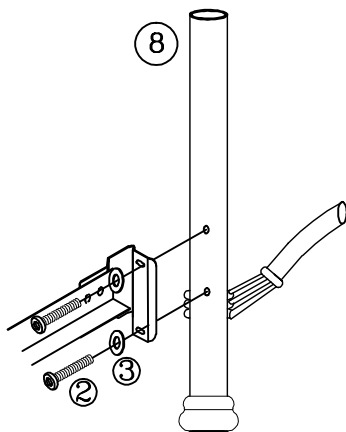

Step 3 Footboard Assembly

- Insert plastic glide (6) on bottom of the post of panel (8). SEE FIGURE 1
- Position panel (8) and align holes in the post with holes in the frame bracket. SEE FIGURE 3
- Place metal washer (3) on each screw (2). Insert through bracket and into panel (8) post. Hand tighten, DO NOT TIGHTEN screws all the way.
- Repeat on other side of footboard panel.
- Tighten all screws securely using the Allen wrench (5).